

KEY FEATURES

- Economical SMA microwave VNA calibration kit with unsurpassed price to performance ratio
- Male and female standards, as well as an SMA torque wrench
- Multiple calibration options depending on VNA model and desired level of precision
- Performance comparisons provided with well-known much more expensive calibration kit allowing you to determine if the accuracy of the kit is suitable for your application
- Each kit has been individually measured and calibration constants specific to each kit are provided to maximize accuracy and performance



WHAT'S INCLUDED

- Male and female Short, Open, Load, Thru (SOLT) SMA calibration standards
- An SMA torque wrench calibrated to 5 lbs-in (0.56 N·m)
- Calibration constants specific for each kit as well as .s2p files for each standard for use with VNAs that support data-file based calibrations on a USB flash drive
- A 6-dB attenuator for verification purposes is included along with its measured performance results that can be used to indicate an accurate calibration
- An open-ended wrench suitable for use with the standards together with the torque wrench
- Rugged custom case designed to perfectly fit and protect the calibration kit components

SPECIFICATIONS

- Connector: SMA
- Impedance: 50 Ω
- Frequency Range: DC to 15 GHz

		Frequency	Reflection Coefficient Magnitude	Phase Error ¹	Calibration Coefficients Provided with Kit
Open	Male	DC to 15 GHz	≥ 0.98	≤ 2°	$C_0 \times 10^{-15}$ (F) $C_1 \times 10^{-27}$ (F/Hz) $C_2 \times 10^{-36}$ (F/Hz ²) $C_3 \times 10^{-45}$ (F/Hz ³) Offset Z_0 (Ω) Offset Delay (sec) Offset Loss (GΩ/sec)
	Female	DC to 15 GHz	≥ 0.98	≤ 2°	

		Frequency	Reflection Coefficient Magnitude	Phase Error ¹	Calibration Coefficients Provided with Kit
Short	Male	DC to 15 GHz	≥ 0.98	$\leq 1^\circ$	$L_0 \times 10^{-12}$ (H) $L_1 \times 10^{-24}$ (H/Hz) $L_2 \times 10^{-33}$ (H/Hz ²) $L_3 \times 10^{-42}$ (H/Hz ³) Offset Z_0 (Ω) Offset Delay (sec) Offset Loss (G Ω /sec)
	Female	DC to 15 GHz	≥ 0.98	$\leq 1^\circ$	

Note: The short standard coefficients have also been optimized for VNAs that do not have the ability to enter the inductance coefficients (L_0, L_1, L_2, L_3). In this case, just use the the Offset Z_0 , Offset Delay, and Offset Loss coefficients.

¹ Phase error is defined as the magnitude of the difference in phase between the measured standard and the modeled standard using the provided calibration coefficients.

		Frequency	Return Loss ²	Power Handling ³	Calibration Coefficients Provided with Kit
Load	Male	DC to 15 GHz	≥ 36 dB	≤ 1 W	Offset Z_0 (Ω) Offset Delay (sec) Offset Loss (G Ω /sec)
	Female	DC to 15 GHz	≥ 27 dB	≤ 1 W	

² Measured return loss prior to correction with the calibration constants.

³ Maximum continuous wave (CW) power at 25°C.

		Frequency	Return Loss	Insertion Loss	Calibration Coefficients Provided with Kit
Thru	Male	DC to 15 GHz	≥ 27 dB	≤ 0.3 dB	Offset Z_0 (Ω) Offset Delay (sec) Offset Loss (G Ω /sec)
	Female	DC to 15 GHz	≥ 27 dB	≤ 0.3 dB	

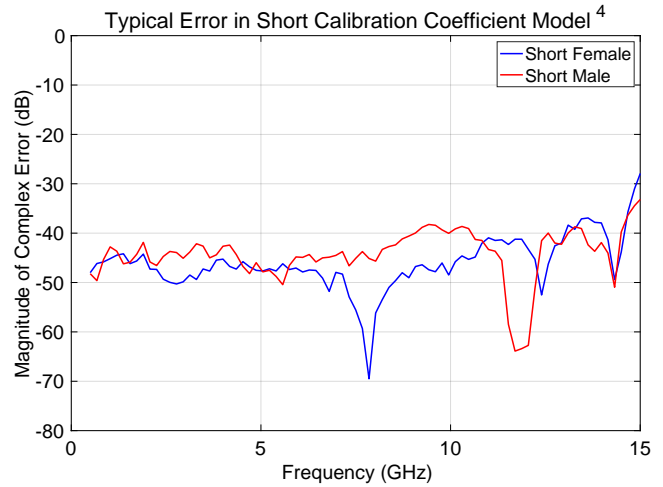
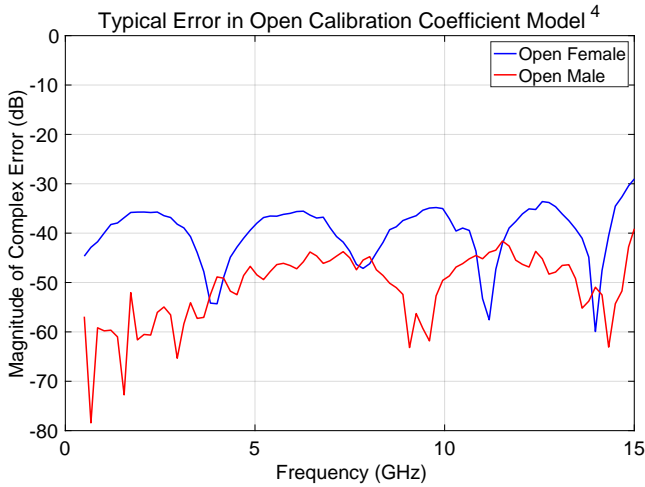

⁴ The error in the calibration coefficient model is defined as follows: Denote the complex (i.e., magnitude and phase) data of the measured S_{11} of the open/short standard by S_{11}^{Meas} and the model's complex response by S_{11}^{Model} . The model uses the calibration coefficients included with each kit that have been fitted to the measured data (this is the model that the VNA will use for correction). The magnitude of the complex error shown in the plots above is defined as $20 \log_{10}(|S_{11}^{Meas} - S_{11}^{Model}|)$ which is a metric for both the magnitude and phase accuracy of the model.

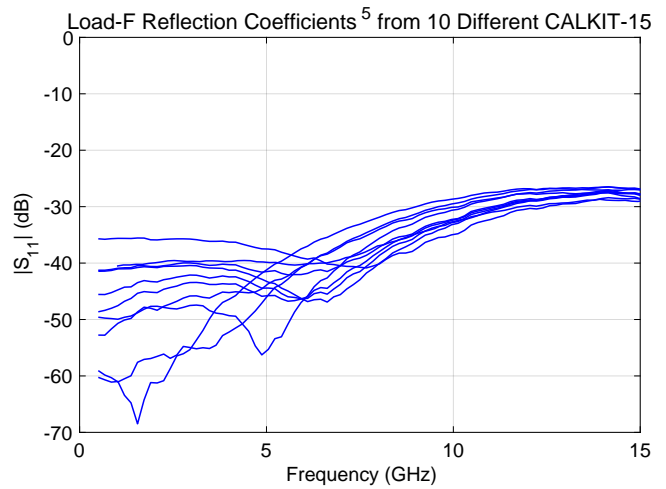
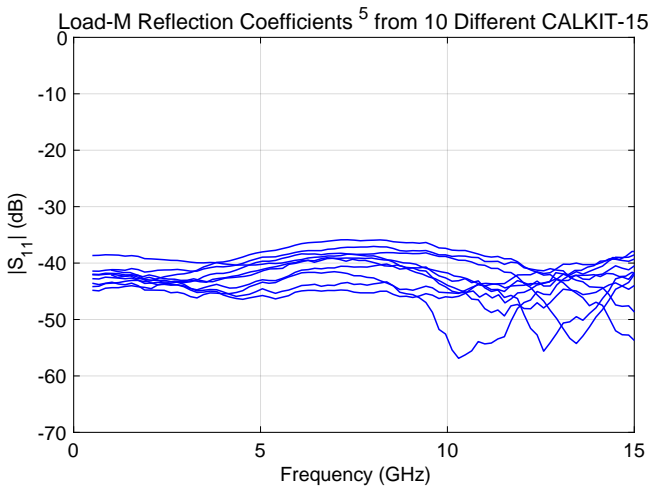

⁵ Measured return loss of the load standards measured after calibrating the VNA with a Keysight 85052D calibration kit. These results are prior to correction with the calibration constants.

PERFORMANCE COMPARISON

In order to illustrate the capabilities and accuracy of the calibration kit in practice, measurement comparisons have been performed for a variety of devices with a common (and much more expensive) calibration kit from Keysight. Device measurement comparisons include a variety of antennas, filters, amplifiers, power dividers, and attenuators. See *Measurement Notes* below for details on the measurement setup.

Calibration Kits Compared:

1. AntenX CALKIT-15
2. Keysight 85052D (\$10,266 USD)

Antennas

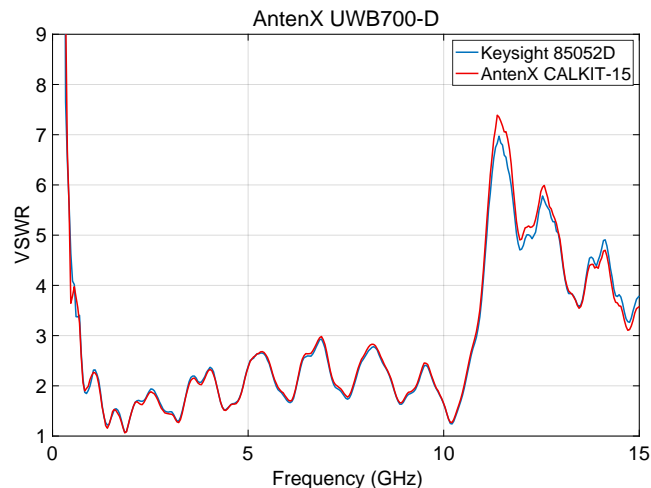

Datasheet: <https://antenx.com/product/uwb700-d/>

Measurement Notes:

- All performance comparison measurements were performed with an HP8720B VNA configured for a resolution bandwidth of 3 kHz, a frequency step of 50 MHz, averaging set to 4, and no smoothing.
- The HP8720B VNA does not have the ability to include the Short standard inductance coefficients (L_0, L_1, L_2, L_3), so only the Offset Z_0 , Offset Delay, and Offset Loss coefficients were used for the Short standard. Improved performance would be obtained if the inductance coefficients were used or if the calibration standard .s2p files provided with the kit were used for a data-based calibration.
- The Keysight 85052D calibration was performed with a precision Keysight 8 in-lb torque wrench and the AntenX CALKIT-15 calibration used the 5 in-lb torque wrench supplied with the kit.
- One port of the VNA was female and the other male, thus requiring use of all SOL standards during calibration.
- In comparison results where only a red line is visible, the lines are overlapping with no visible performance difference (i.e., the blue Keysight 85052D line is directly underneath the red AntenX CALKIT-15 trace).

Filters

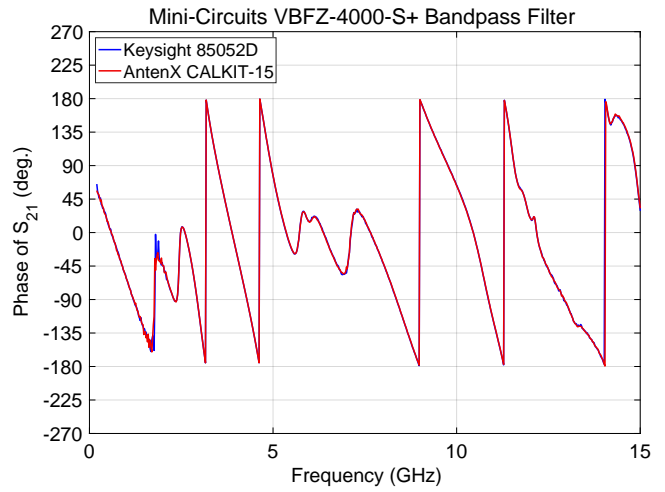
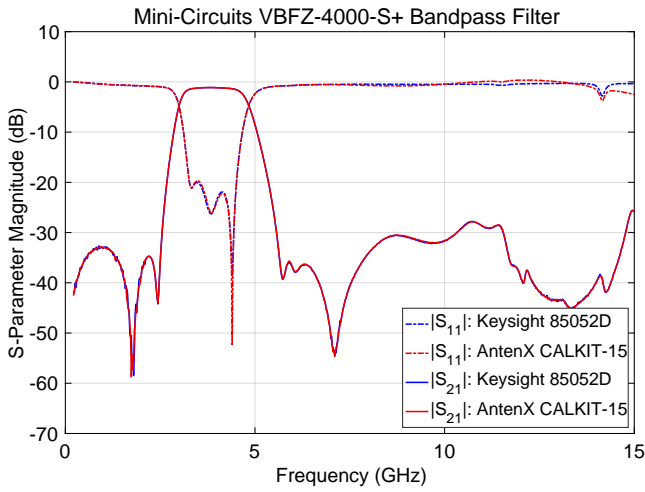

Datasheet: <https://www.minicircuits.com/pdfs/VBFZ-4000+.pdf>

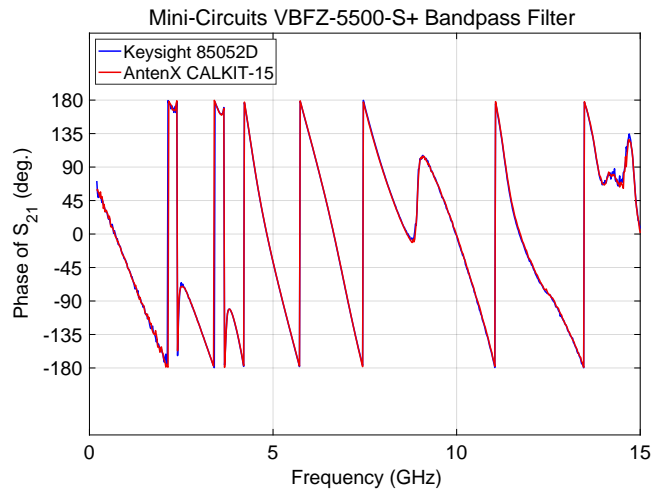
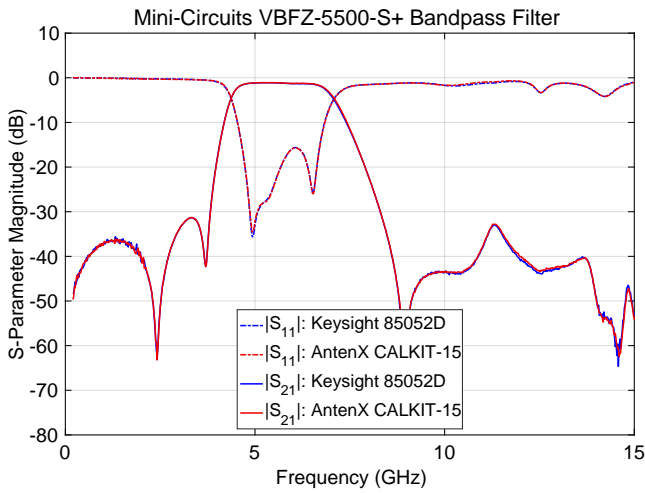

Datasheet: <https://www.minicircuits.com/pdfs/VBFZ-5500+.pdf>

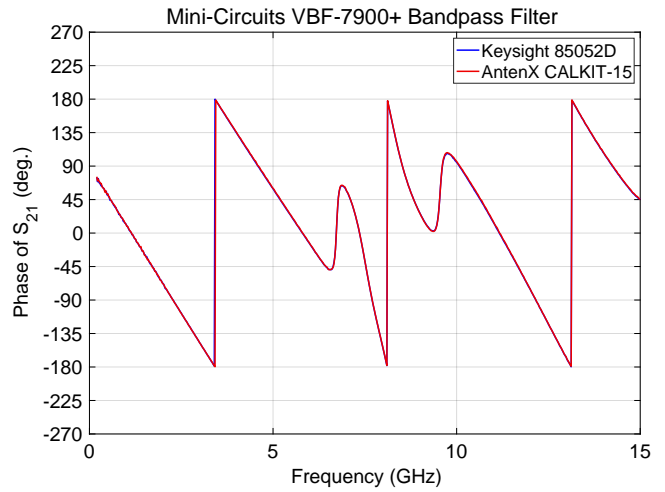
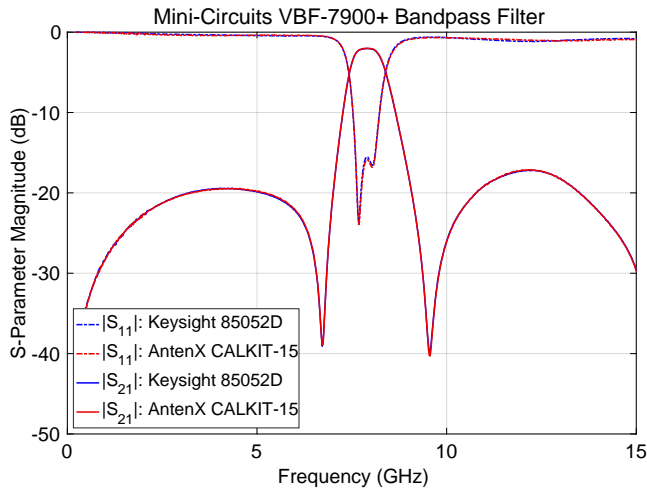

Datasheet: <https://www.minicircuits.com/pdfs/VBF-7900+.pdf>

Amplifiers

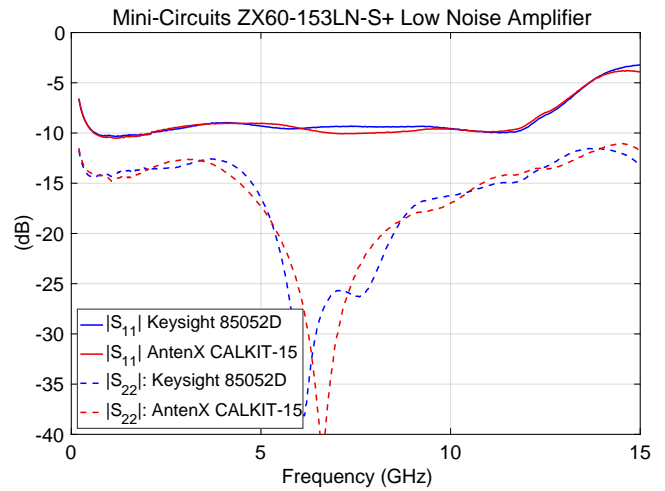
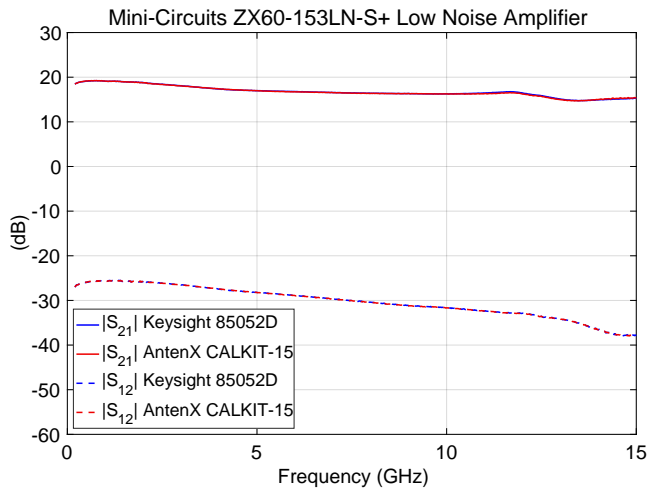

Datasheet: <https://www.minicircuits.com/pdfs/ZX60-153LN-S+.pdf>

Power Dividers

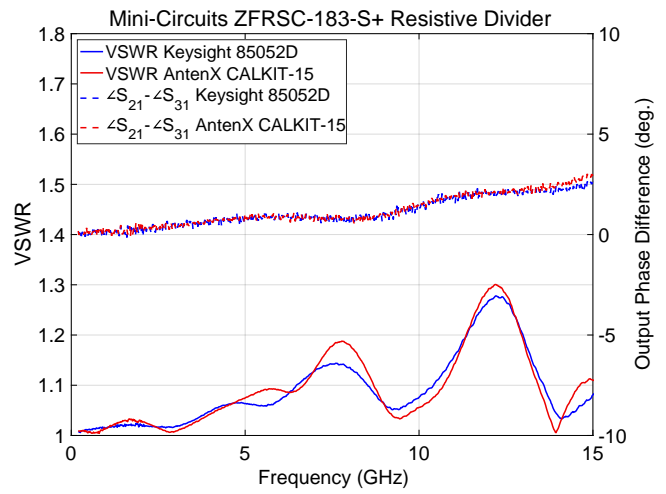
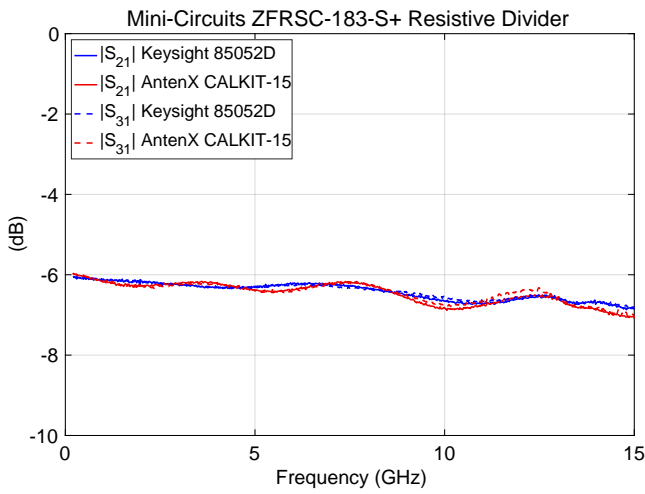

Datasheet: <https://www.minicircuits.com/pdfs/ZFRSC-183-S+.pdf>

Attenuators

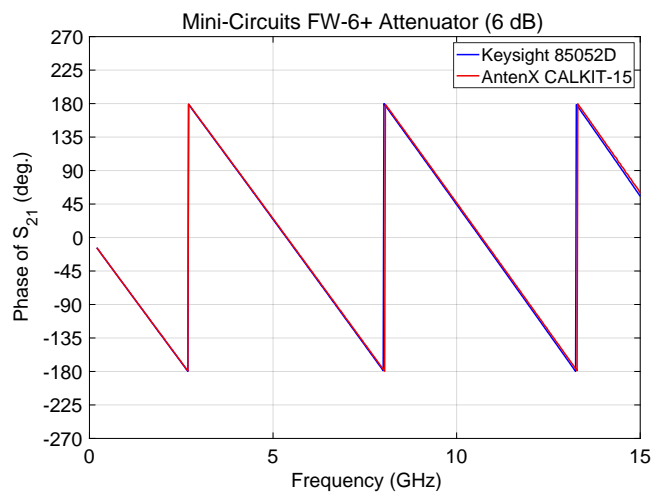
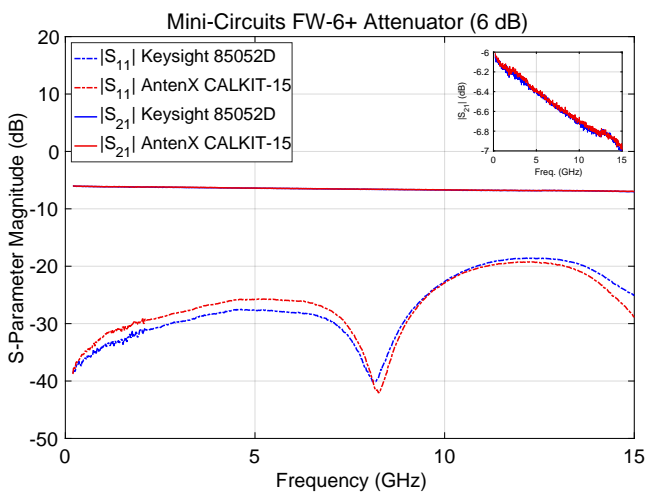

Datasheet: <https://www.minicircuits.com/pdfs/FW-6+.pdf>

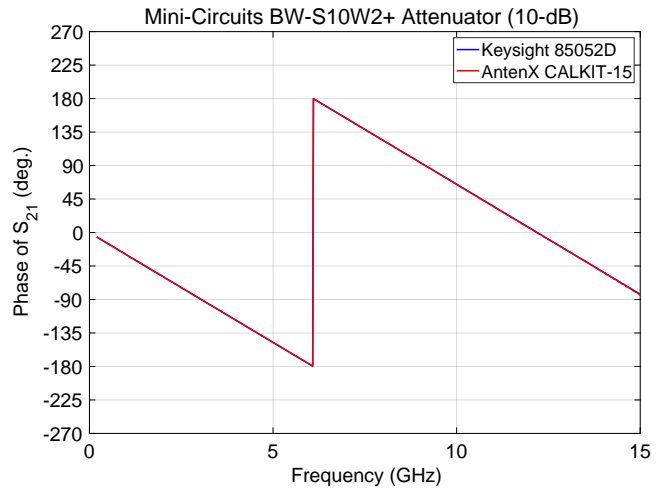
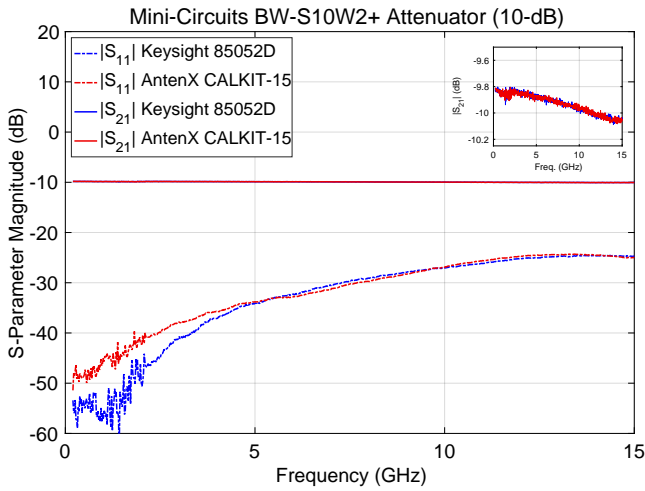

Datasheet: <https://www.minicircuits.com/pdfs/BW-S10W2+.pdf>

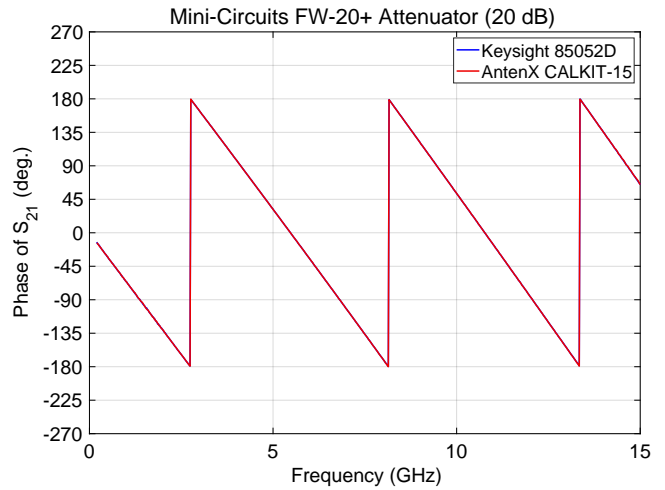
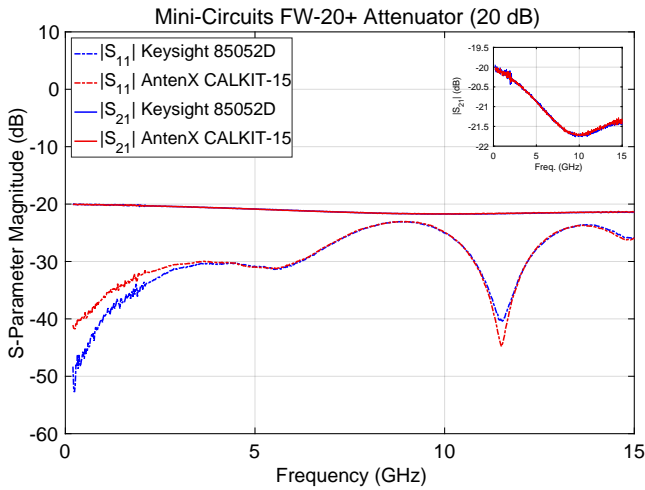

Datasheet: <https://www.minicircuits.com/pdfs/FW-20+.pdf>